

Assembly Instructions SMMSD - Modular Slatwall Display

Rev 20.10

Scan QR code to visit
the product page:



If you have any questions regarding our products, please visit us at www.displays2go.com or contact D2G customer service 844-221-3388.

Parts List

Side bracket
2 PCS

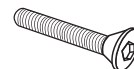
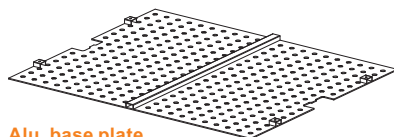
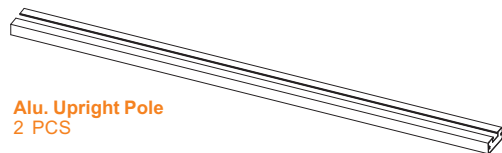
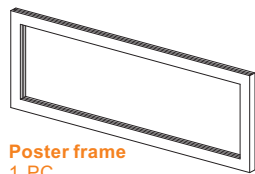
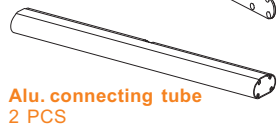
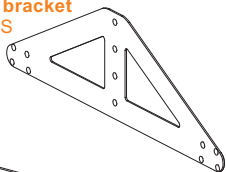

M6x20 Hex Drive Flat head Screws
24 PCS



M4x16 Phillips Rounded Head Screw
6 PCS



M4x8 Phillips Low Profile Head Screw
4 PCS



M4x16 Phillips Flat Head Screw
8 PCS



Hex Wrench
1 PC

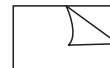

User manual
1 PC

Assembly Instructions

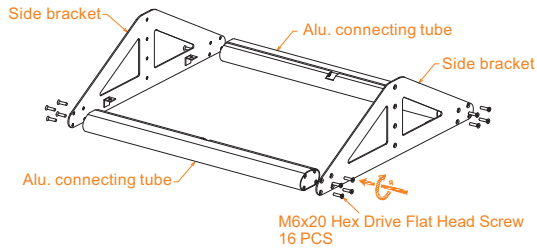

Step 1

Assemble the base by connecting 2 side brackets with 2 Aluminum Tubes using 16 M6x20 Hex Drive Flat Head screws as shown above.

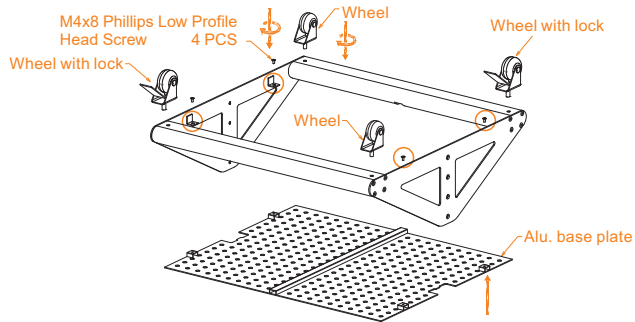

Step 2

Carefully turn the assembled base upside down and screw in 4 wheels at the 4 corners. Attach the Base Plate to the tabs on the base from the bottom and fix it using 4 Low Profile Head Screws.

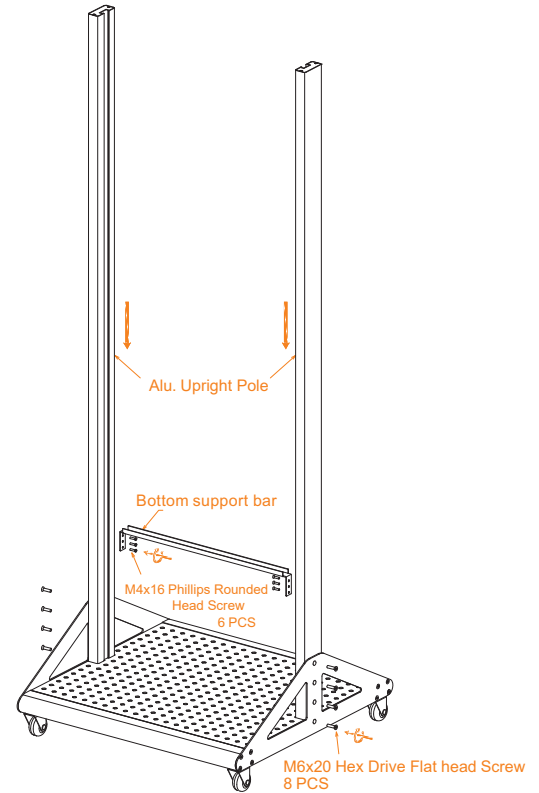

Step 3

Put the assembled base on its standing position. Insert the 2 Upright Poles into the cutsouts on the base plate, and fix them using 8 M6x20 Hex Drive Flat Head screws. Place the bottom support bar into the channels on the upright poles and fix it using M4x16 Phillips Rounded Head Screws.

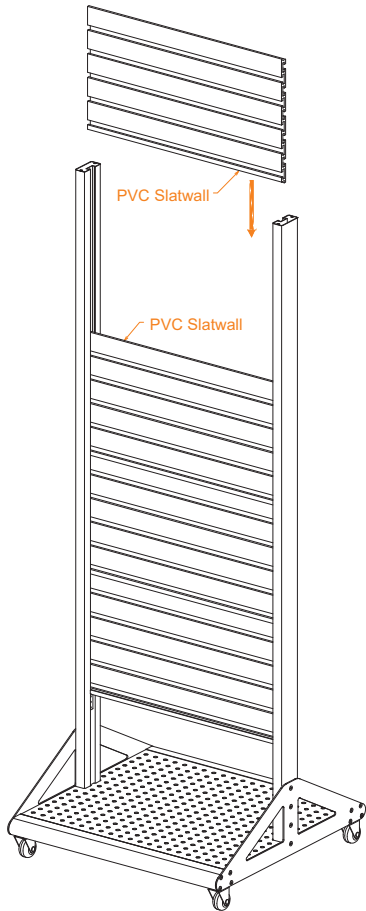

Step 4

Slide 1 PVC Slatwall Panel down from the top and rest on the support bar. Assemble the remaining PVC panels the same way.

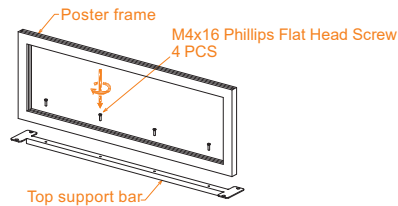
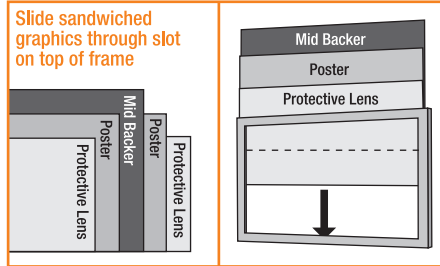

Step 5

Remove the lens and back sheet from the poster frame. Securely Fix the poster frame onto the top support bar using 4 M4x16 Phillips Flat Head Screws. Sandwich your posters and back sheet as shown above and insert back to the poster frame.

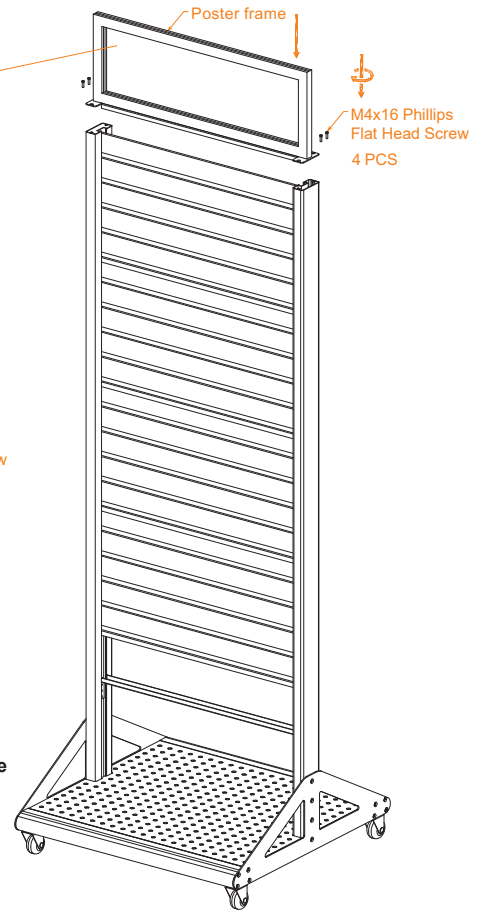

Step 6

Mount the poster set onto the straight poles using 4 M4x16 Phillips Flat Head Screws. The assembly is finished.